



**FO SPLICE CLOSURE
MECHANICAL
144 FO - IP68**

AR-SC4P-144F-I-M

Description

Series of fiber optic splice closure is a kind of multi-purpose optical cable connection product, which can connect and divide optical fiber. The box can be applied to a variety of optical cable (loose sleeve, skeleton, ribbon, etc.) and can be installed in a variety of environments (overhead, wall, pipe-line, manhole, underground), and for a variety of connecting methods (distribution, bridge, branch, etc.).

Feature

- Structure: Compact, watertight and no screw design, open easily and user friendly
- Capacity: SC-H072-01 support maximum 72 cores; SC-H072-01-B support maximum 288 cores
- Diameter: total 4 ports and suitable for Φ 10 to 18 mm cable
- Sealing: Box sealed by buckles around and cables ports sealed by nuts to meet IP68
- Installation: Aerial mounting, Manhole mounting, Wall mounting and underground

Specification

Model No.	AR-SC4P-144F-I-M
Style	In-line/ Horizontal
Dimensions	487(L)×194(W)×118(H) mm
Weight (kg)	3.5 - 4.0
Material	PP+GF
Sealing Type	Mechanical Seal
Protection Grade	IP68
Cable ports	4
Cable diameter	Φ 10 - 18 mm
Fiber Splice Capacity	72
Tray Capacity	24
Tray Count	3
Application	Aerial mounting, Manhole mounting, Wall mounting and underground

Model No.	AR-SC4P-144F-I-M-B
Style	In-line/ Horizontal
Dimensions	525(L) × 200(W) × 151(H) mm
Weight (kg)	3.5 - 4.0
Material	PP+GF
Sealing Type	Mechanical Seal
Protection Grade	IP68
Cable ports	4
Cable diameter	Φ 10 - 18 mm
Fiber Splice Capacity	144
Tray Capacity	24
Tray Count	6
Application	Aerial mounting, Manhole mounting, Wall mounting and underground



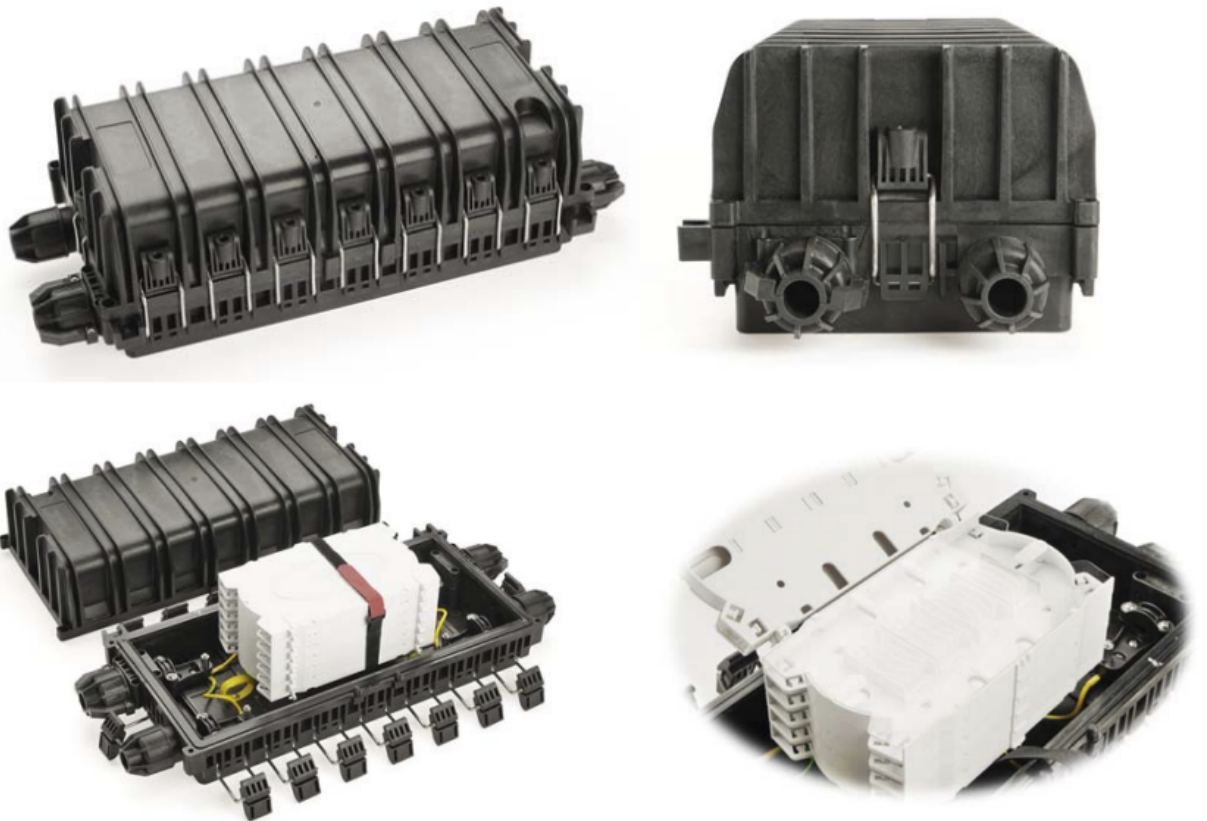

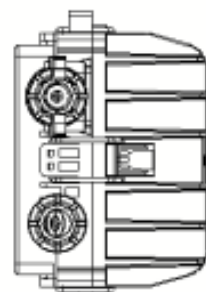
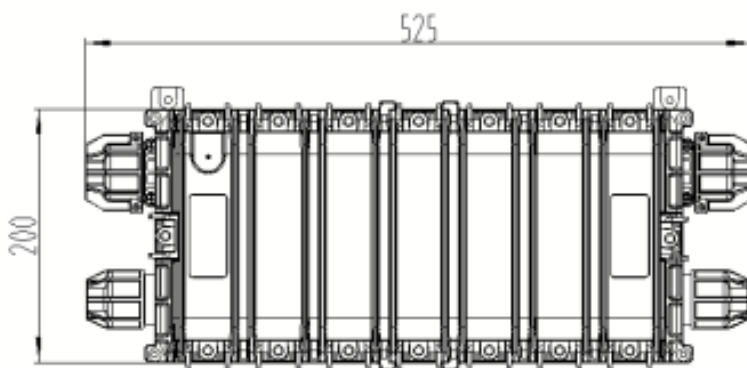
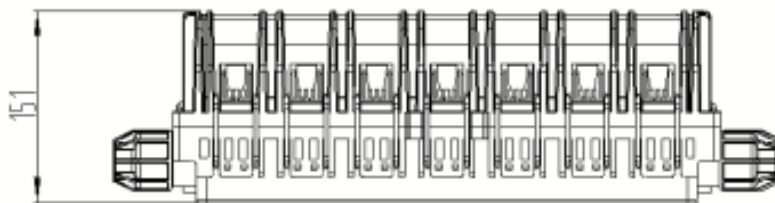
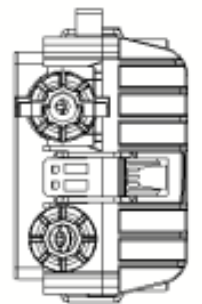
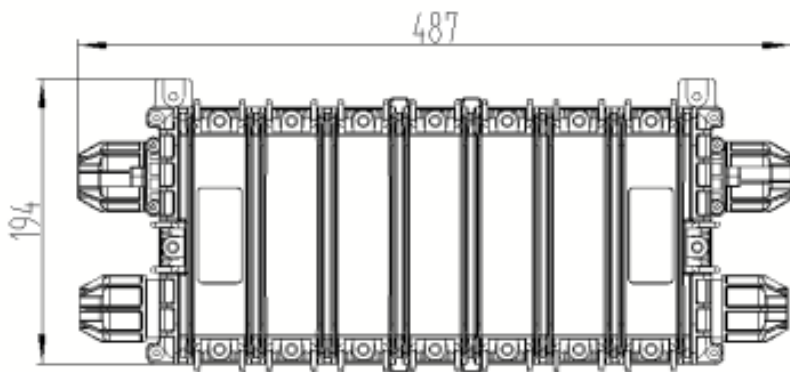

Product appearance









Accessory

Standard accessories (Picture only for refer)

Item	Description	Qty	Picture
1	Insulation tap	1 roll	
2	Splicing protective tube	1 bag	
3	Nylon cable tie	1 bag	
4	Choke plug	2 pcs	
5	Installation manual	1 set	
6	EVA tube	1 roll	

Optional accessory

Item	Description	Qty	Picture
1	Air valve	1 set	
2	Aerial mounting fittings	1 set	
3	Wall mounting fittings	1 set	
4	Ground lead	1 set	

Ordering information

Type	Size	Inner Carton size	Outer carton size
AR-SC4P-144F-I-M	487×194×118mm	510×220×150 mm (1PCS)	530×460×480 mm (6 PCS)
AR-SC4P-144F-I-M-B	525×200×151mm	540×220×180 mm (1PCS)	560×460×570 mm (6 PCS)